

High Productivity Cooking 80-lt gas tilting braising pan with Duomat cooking surface, thermostatic control - Tunisia

ITEM # _____

MODEL # _____

NAME # _____

SIS # _____

AIA # _____

391302 (E9BRGHDOFW)

 80-lt gas tilting Braising Pan
 with Duomat cooking
 surface, thermostatic control
 - Tunisia

Short Form Specification

Item No.

Suitable for natural gas or LPG. Burners in AISI 441 with flame failure device. Duomat cooking surface for roasting, browning, stewing, preparation of sauces, sautéing, boiling and braising. Can be installed on cantilever systems. Installation on wheels is not available. Includes mechanism to manually tilt the pan and double-skinned lid in stainless steel. Cooking temperature can be set through thermostat and the energy input through an energy regulator. Exterior panels of unit in stainless steel with Scotch Brite finish. Right-angled side edges to allow flush-fitting junction between units.

Main Features

- Bratt pan ideal for sautéing, poaching, steaming, boiling, stewing and damp cooking.
- Duomat cooking surface allows to perform wet and dry cooking alternatively.
- Double-skin well and lid to reduce heat dispersion.
- Lid is double-lined, insulated in 20/10 Stainless steel.
- Actual cooking temperature setting through adjustable thermostat.
- Energy input controlled by energy regulator.
- Manual tilting mechanism to facilitate pan emptying.
- Smooth large surfaces, easy access for cleaning.
- The special design of the control knob system guarantees against water infiltration.
- Working temperature can be set from 80 °C to 300 °C.

Construction

- Cooking surface with Duomat bottom: a 10 mm-thick alloy obtained from the combination of 2 different stainless steels for better thermal stability and corrosion resistance.
- Burners in chrome plated steel with flame failure device, optimized combustion and piezo ignition with electronic flame control.
- All pan internal surfaces round and polished for better hygiene.
- Usable capacity of the well 66 liters.
- IPX5 water resistance certification.

Sustainability



- Heat-insulated: limited heat radiation and low energy consumption.

Optional Accessories

- Draught diverter, 150 mm diameter PNC 206132
- Matching ring for flue condenser, 150 mm diameter PNC 206133
- Flanged feet kit PNC 206136
- Frontal kicking strip for concrete installation, 800mm PNC 206148
- Frontal kicking strip for concrete installation, 1000mm PNC 206150
- Frontal kicking strip for concrete installation, 1200mm PNC 206151
- Frontal kicking strip for concrete installation, 1600mm PNC 206152
- Frontal kicking strip, 800mm (not for refr-freezer base) PNC 206176
- Frontal kicking strip, 1000mm (not for refr-freezer base) PNC 206177
- Frontal kicking strip, 1200mm (not for refr-freezer base) PNC 206178
- Frontal kicking strip, 1600mm (not for refr-freezer base) PNC 206179

APPROVAL: _____



- Pair of side kicking strips (not for refr-freezer base) PNC 206180
- 2 panels for service duct for single installation PNC 206181
- 2 panels for service duct for back to back installation PNC 206202
- Kit 4 feet for concrete installation (not for 900 line free standing grill) PNC 206210
- Flue condenser for 1 module, 150 mm diameter PNC 206246
- Chimney upstand, 800mm PNC 206304
- Rear paneling - 800mm (700/900) PNC 206374
- Rear paneling - 1000mm (700/900) PNC 206375
- Rear paneling - 1200mm (700/900) PNC 206376
- Chimney grid net, 400mm (700XP/900) PNC 206400
- Kit G.25.3 (NI) gas nozzles for 700 and 900 braising pans PNC 206464
- Trolley with lifting & removable tank PNC 922403
- Pressure regulator for gas units PNC 927225

Recommended Detergents

- C41 HI-TEMP RAPID DEGREASER, 1 pack of six 1 lt. bottles (trigger incl.) PNC 0S2292

Front

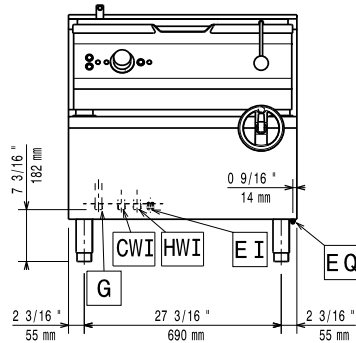

Side

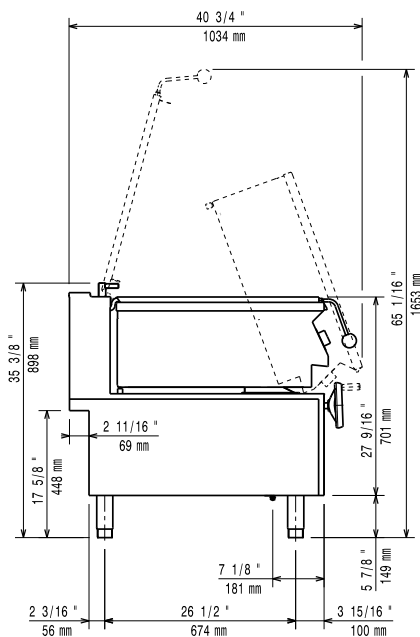

CWI = Cold Water inlet 1 (cleaning)
 EI = Electrical inlet (power)
 G = Gas connection

Top

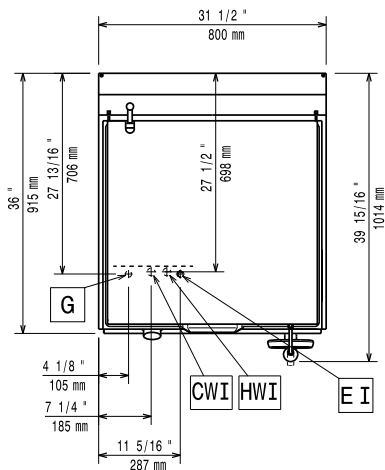

Electric

Supply voltage: 220-230 V/1 ph/50 Hz
Total Watts: 0.1 kW

Gas

Gas Power: 21 kW
Standard gas delivery: Natural Gas G20 (20mbar)
Gas Type Option: LPG; Natural Gas
Gas Inlet: 1/2"

Key Information:

External dimensions - No clearance needed on rear sides of unit if wall is of non combustible type. If wall is combustible, minimum 50 mm wall clearance should be maintained.

Cooking Surface Depth: 565 mm
Cooking Surface Width: 680 mm
Cooking Well Height: 130 mm
Well Capacity, Max: 80 lt
Working Temperature MIN: 80 °C
Working Temperature MAX: 300 °C
External dimensions, Width: 800 mm
External dimensions, Depth: 930 mm
External dimensions, Height: 850 mm
Certification group: N9EBRG